



All-in-One Mobile C-arm with Integrated FPD

BELLIGER ACE



Key Features

Experience next-level innovation in space utilization, imaging precision, and procedural performance — all with an **integrated FPD**

All-in-One Body

Compact Design for Optimal Use of Limited Space.

Free Space 860mm

Enhanced Free Space for Unrestricted Procedures.

High-Speed Image Processing

GENORAY's advanced low-latency technology minimizes image delay, delivering fast and accurate images that maximize procedural efficiency.

Low-Dose Technology for Patients and Users

GENORAY's low-dose technology minimizes radiation exposure without compromising image quality — protecting patients and reducing long-term risks for medical staff.





Product Overview



All-In-One Body Design



3.2kW HFG



Free Space 860mm



20x20cm CMOS
/ 21x21cm TFT



27" Touch Monitor



Digital Subtraction
Angiography

With its All-in-One design, there's no need for a separate cart — freeing up valuable space in the procedure room.

BELLIGER ACE

ZENIS IV plus

Upgraded UI for the Optimal Diagnostic Environment

Clinical Data

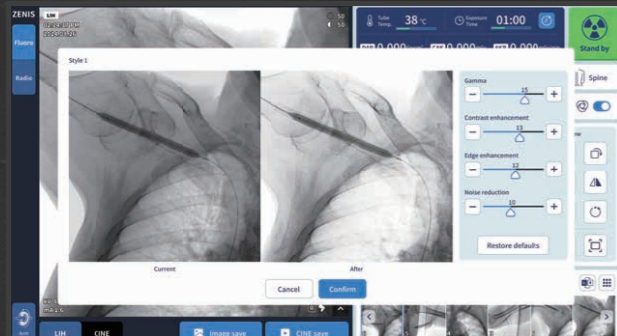

DNR (Dynamic Noise Reduction)

Dynamic Noise Reduction eliminates image noise, delivering sharper and more reliable images.

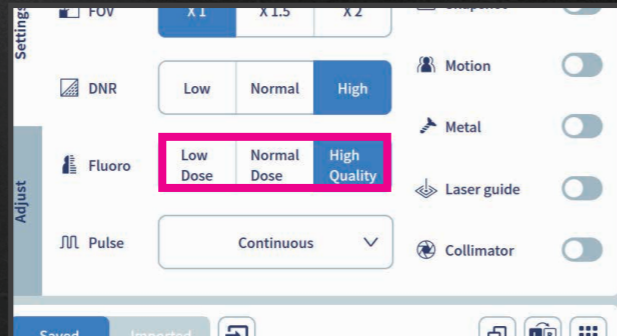

Dose Level Adjustment

Optimized dose adjustments ensures safe use in various dose modes, while consistently delivering clear images for every patient and procedure.

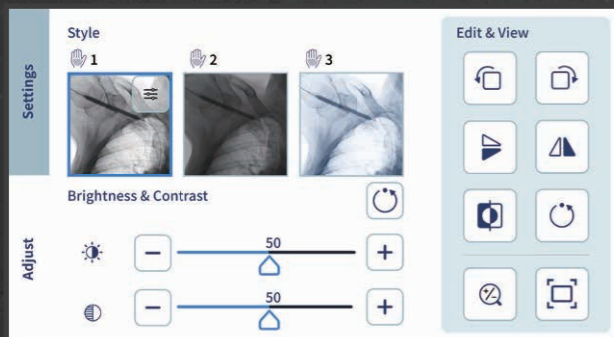

Style Template Function

Offers three customizable imaging styles, allowing users to choose their preference and create an optimal imaging environment.



Snap Shot

While in real-time fluoroscopy, users can capture their desired still image in high resolution.

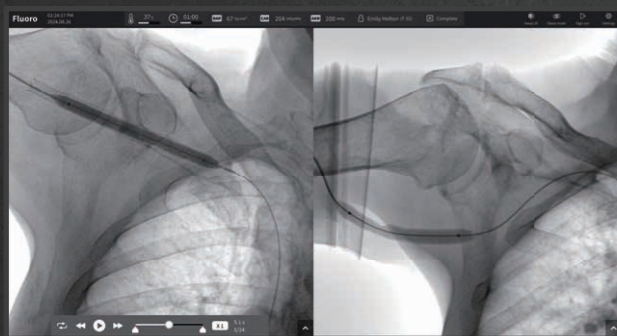

Real-Time Image Comparison - Swap

Freely switch between live and reference images, to enable an accurate comparative diagnosis and localization for procedures.

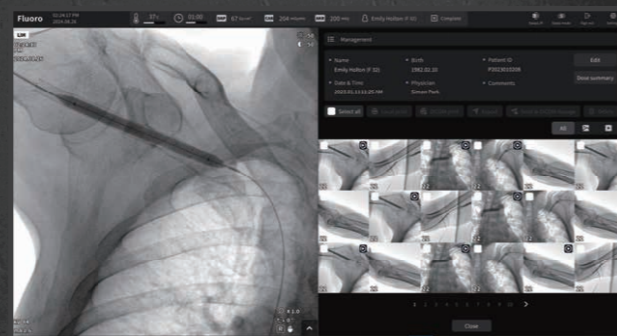
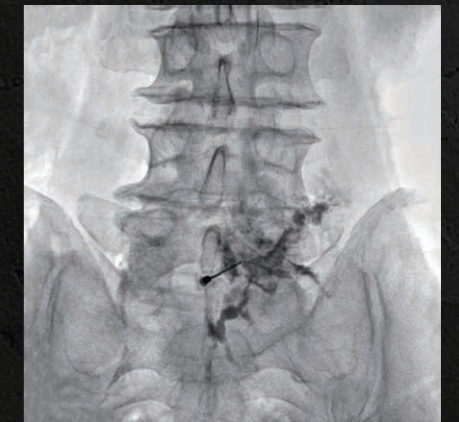

Image Scroll Function

Stored images can be reviewed quickly while scrolling, making it much more efficient.

Pain management



Orthopedics

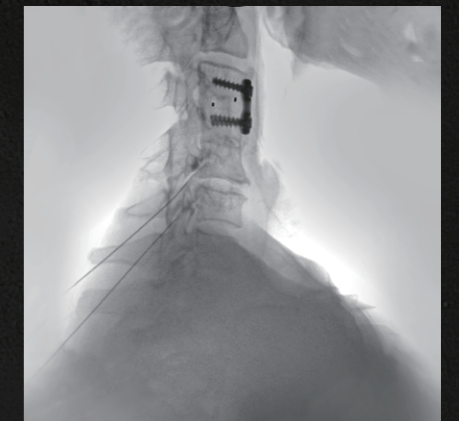
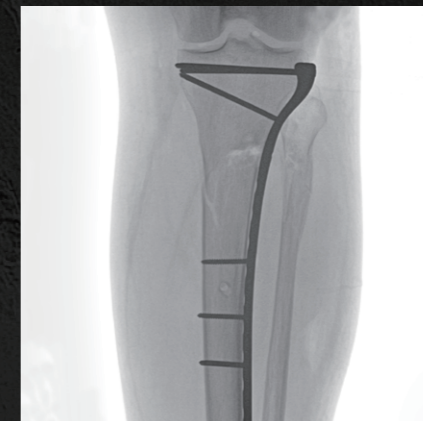

DSA *Option

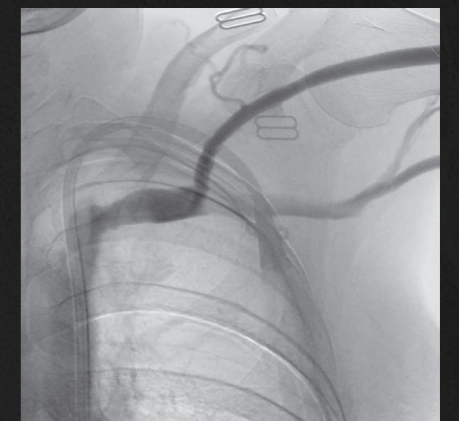
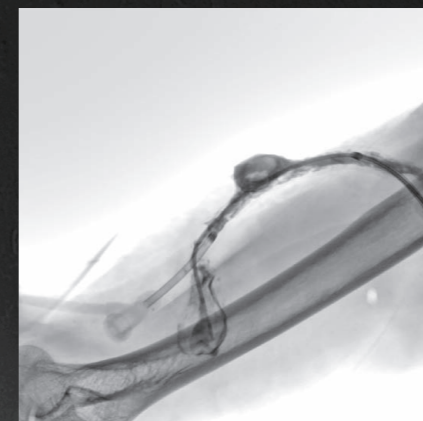

Live image with Contrast Medium injection

Dimensions

Minimum Installation Space Required

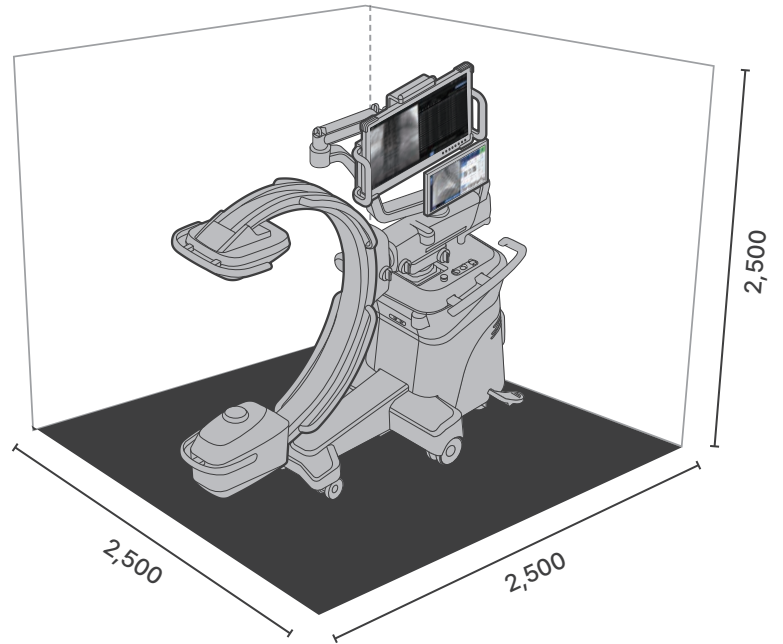

GENORAY Co.,Ltd.

T +82-31-5178-5500
E genoray@genoray.com
W www.genoray.com

GENORAY America Inc.

T +1-855-436-6729
E inquiry@genorayamerica.com
W www.genorayamerica.com

GENORAY EU GmbH

T +49-30-50969498
E info@genorayeuropa.com
W europe.genoray.com

GENORAY Japan

T +81-45-620-4971
E Info@genorayjapan.co.jp
W www.genorayjapan.co.jp

GENORAY Türkiye

T +90-216-463-57-37, +90-216-463-57-53
E genorayturkiye@genoray.com
W turkiye.genoray.com

GENORAY Shanghai

T +86-021-6785-8538
E genoraychina@genoray.com
W www.genoray.com.cn